

TLX Basic DWS System



TLX Basic Quick Guide

Table of Contents

1.	Safety Instructions	2
	Conveyor Belt Operating Safety Guidelines.....	2
	Electrical Safety	2
	Laser Safety	3
	The Dimensioner and the Barcode readers operate using laser beams.....	3
	The following recommendations apply concerning laser safety:.....	3
	Electrostatic Precautions	3
2.	Specifications and Configurations	3
	General Information	3
	Technical Specifications	4
3.	Operating Instructions.....	5
4.	Diagnostics and Maintenance	9
	Status and error codes	9

1. Safety Instructions

Conveyor Belt Operating Safety Guidelines



Major safety concerns associated with conveyor belts include:

- Becoming trapped in and being crushed by the conveyor belt
- Being struck by objects falling from a conveyor

To reduce the potential for injury, workers must:

- Not wear loose clothing or jewellery at or near the conveyor
- Not put their hands on or reach for objects on a moving conveyor belt
- Not work or store material under the unguarded conveyor belt
- Not walk on the conveyor belt unless the power supply is locked and tagged out.

Before operating a conveyor the worker must be familiar with:

- How to use and the location of all controls and emergency stop devices.
- The location of the lock out point and how to lock out the conveyor
- The load limits
- All actual and potential hazards related to the conveyor

Before operating the conveyor belt, the first time on a shift, the worker must confirm that:

- The loading/unloading areas are free of slip and trip hazards
- Emergency stop(s) and all other controls are functioning properly
- No one is working under the conveyor belt.
- No one is working within the fall zone beside the conveyor belt
- The conveyor belt is free of tears or material caught between the belt and the rollers

While operating the conveyor belt the worker will:

- Remain within reaching distance of an emergency stop control.
- Be aware of how the load is moving
- Be concerned about potential bottle necks and take appropriate actions
- Be aware of other workers who may move into the fall/risk zone
- Be aware of and comply with the load capacity

The weigh cells of the scale belt are a very sensitive precision measuring instrument and must therefore be handled with care:

- Shocks, jamming, or objects falling on the scale belt conveyor must be avoided.
- Never put tools on the weighing belt conveyor.

Electrical Safety



To avoid electric shock the following recommendations should be observed:

- Only a qualified electrician may work on electric systems, components or process materials and must supervise the staff; and the electrical engineering rules and accident prevention regulations must be observed!
- The electric parts of the machine/system must be regularly inspected and thoroughly checked. Any faults – e.g. loose connections or charred cables – must be cleared immediately. Do not operate unsafe equipment!

Laser Safety

The Dimensioner and the Barcode readers operate using laser beams.
The following recommendations apply concerning laser safety:



- Avoid direct viewing into the laser beam unless absolutely necessary (general recommendation that also applies for Class 1 lasers). If direct viewing is necessary, reduce the exposure time to a minimum and do the viewing at maximum possible distance.
- Do not intercept the laser beam with a mirror or any other reflective material or optical components.

Electrostatic Precautions

The TLX components contain electrostatic sensitive components and must be handled with care.
The following recommendations apply concerning electrostatic safety:



- Only a qualified electrician may work on electric systems, components or process materials and must supervise the staff; and the electrical engineering rules and accident prevention regulations must be observed!
- Only trained/Mettler Toledo qualified technicians may remove covers on system components.
- Electromagnetic environment class E2: This class applies to automatic checkweighers used in locations with electromagnetic disturbances corresponding to those likely to be found in other industrial buildings.

2. Specifications and Configurations

General Information

TLX basic can be delivered in different configurations, the below alternatives are the most used:

- Three belt system: First belt for product separation, second belt for measuring and merging of data from weight, dimensioner and barcode and third belt can be use for product verification.
- Two belt system: First belt for product separation, second belt for measuring and merging of data from weight, dimensioner and barcode.
- One belt system: there is only one belt for measuring and merging of data from weight, dimensioner and barcode. The customer need ensure the parcel distance far enough.

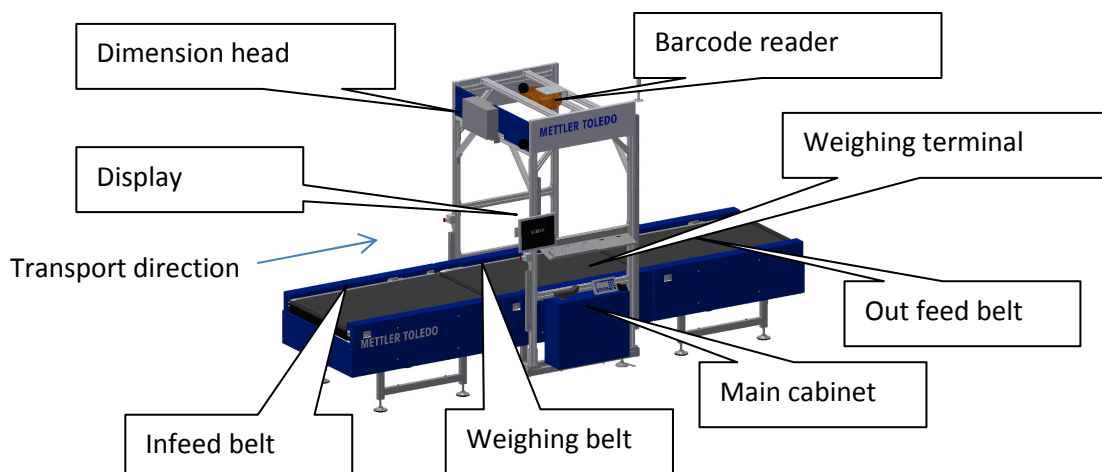

Pick one Quick Guide, print it out and mount it by the system. You have following alternatives:

Configuration	Dimensioner	Software running in	Software	Human Interface	Comment
Three belts system (Separate, measure)	CSN950	CSN950	OCTO infeed	DELL monitor	Weight, Dimension and ID System
Two belts system (Separate & measure)	CNS950	CSN950	OCTO infeed	DELL monitor	Weight, Dimension and ID System
One belt system (measure)	CSN950	CSN950	OCTO infeed	DELL monitor	Weight, Dimension and ID System

Technical Specifications

Dimensioner	Cuboidals: CSN950
Scale	ICS469-100 DMS
Barcode Reader	Datalogic automatic DX8K or handheld barcode reader
HMI	Normal, Dell
Application Software	OCTO™ Software
Belt Lengths	1500 mm/each
Dimensioning Accuracy	± 2 mm (H), ± 5 mm (L & W)*
Maximum Parcel Size	1200 x 900 x 900 mm** (LxWxH)
Minimum Parcel Size	150 x 50 x 25 mm (LxWxH)
Weighing Accuracy	50g(LFT)
Weighing Range	250g - 60 kg
Throughput	Up to 1800 parcels per hour
Speed	Up to 60 m/min
Shape	Any shape
Surface Characteristics	All surfaces
Required Spacing	15cm between parcels if equips separate belt

	1600mm front to front if without separate belt
Operating Temperature	0°-40°C (32°-104°F)
Power	1 x 230 VAC + N
Laser Type	Class II
Interfacing	Standard: FTP or TCP/ IP
Operation Modes	Configurable
Flexible Weighing Point	No
Static Weighing	NO
Customer Specific Interfaces	Yes
Image Capture	NO
Parcel Spacing	Yes
Remote Diagnostics	Yes

3. Operating Instructions

Turn on system:

1. Remove all packages from belt in measuring area, before power on system!
2. Turn ON main switch. Switch is located at main electrical-cabinet.
 - Boot up time is estimated to about 2 minutes.
 - Dynamic scale is automatic zeroed.



Start of system:

1. Push the green button, the system motor will be ready start
2. Push the "F5 Start" menu on OCTO software, the belt can run.
3. When system is ready, GREEN lamp lights up on main electrical cabinet.



Three belts solution

Operating mode:	Belt direction	Product separation: x = YES	Collect dimension, weight and barcodes		Stop position, if barcode not read
	Forward *		Yes	No	
Infeed mode	x	x	x		Stop On 1 st belt
Automatic scan	x	x	x		Stop on 3 rd belt
Transport mode	x			x	No stop

TLX basic does not provide backward function

Two belts solution

Operating mode:	Belt direction	Product separation: x = YES	Collect dimension, weight and barcodes		Stop position, if barcode not read
	Forward *		Yes	No	
Infeed mode	x	x	x		Stop On 1 st belt
Automatic scan	x	x	x		MT send one error signal to customer
Transport mode	x			x	No stop

TLX basic does not provide backward function

One belts solution

Operating mode:	Belt direction	Product separation: x = YES	Collect dimension, weight and barcodes		Stop position, if barcode not read
	Forward *		Yes	No	
Infeed mode	x		x		MT send one error signal to customer
Automatic scan	x		x		MT send one error signal to customer
Transport mode	x			x	No stop

TLX basic does not provide backward function

Operate the system:

1. Start main conveyor system with parcels.
2. When parcel comes to separator belt, parcel will be separated so one parcel is in measure area at a time.
3. Once parcel has passed the Dimensioner. OCTO software will animate the parcel on belt.
4. Status of result will show with a color code in animation window.
Good result = Green box with red cross and grey line.
5. Status will also be shown in log after parcel has passed window. Text in black indicates good result.
6. If some information is missing, box will continue to next belt.
7. Measure result will also be sent from OCTO to Host computer.
8. Ready for next package.
 - Only one box on belt in measuring area, at a time!
 - For good measurement. Place the most stable side of box down to belt!
 - Barcodes must face in direction toward the barcode readers to be read!

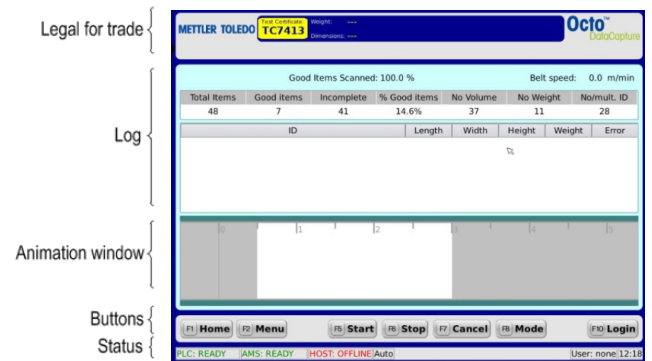

Barcode Scanning Modes:

1. Infeed Barcode Scanning mode
 - The operator need scan the barcode when at infeed belt.
2. Automatic Barcode Scanning mode
 - If barcode is missing, type in or scan in the barcode with handheld barcode reader.
 - Press GO and belt will continue.

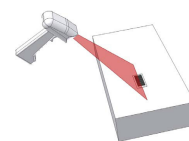

Stopping the System

1. Stop conveyor belt, push the red button Or "F6 stop" to stop the belt

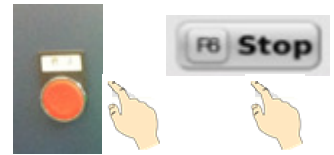

Turn OFF system:

1. Empty the belt for boxes in measuring area.
2. Shut down the running computer from OCTO menu.
Go to MENU > QUIT > SHUT DOWN.
3. Turn OFF main switch. Switch is located at main electrical-cabinet.



Emergency stop of system

1. In case of emergency. Press the red emergency-switch, to stop the system!
OCTO software confirms by showing "Emergency stop pressed" on monitor.
2. To release.
 - a. Rotate red push button switch and pull it softly out.
 - b. (The main conveyor system, may also need to be reset).
3. System is ready when the message in OCTO has disappeared.



Lampstack: Logic is customer specific. Standard option.

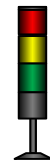

















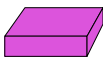



Lampstack

Objects to be measured:

- Legal for trade: Only cuboidal objects.
- Non legal for trade: Other shapes may vary from quoted specifications.



Symbols and colors in Animation window:

Symbol:	Symbol description:	Status:	Comment:
	Box WHITE		Item is waiting for merging
	Box RED		Item with a dimension error.
	Box GREEN		Item measured and merged with barcodes. (Valid barcodes and content)
	Box PINK		No barcodes or valid content. (Item measured but not merged with barcodes)
	Cross BLUE		Barcode waiting for merging to item.
	Cross RED		Barcode merged with an item.
	Cross GRAY		Bar code without an item
	Line BLACK		Weight value waiting for merging
	Line GRAY		Weight value merged with an item
	Line RED		Weight value without an item

Do`s:

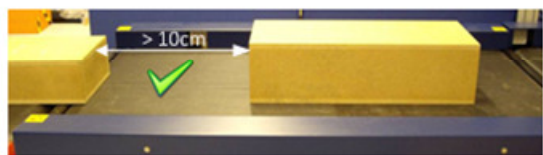
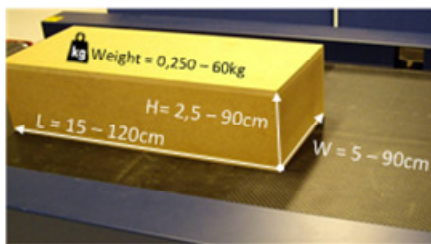

Don`t:

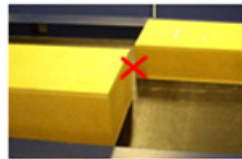

4. Diagnostics and Maintenance

Status and error codes

These codes are valid for systems that use standard data validation logic. Any customer-specific systems may have a different set of codes.

Code:	Explanation
	OCTO Generic codes.
0	Valid package data record.
2	Multiple valid parcel ID bar codes are found for a single package.
4	Single bar code may belong to multiple items. This may happen when the label is placed to the edge of the package and there is another piece next to it on the conveyor. If it is not possible to detect a proper piece to which the code may belong to then it is processed as a separate bar code record with a given status code, not belonging to any of the detected pieces.
6	Bar code is not captured for the item. Code is not read by scanner due to the bad placement, quality or the size of the label.
7	Dimensions are not captured for the item. This code is usually given when low profile items are processed and item is not detected by dimensioning instrument.
8	Volume measuring failed. This happens when processing unsupported piece types (non-cuboidal items for example) or item is outside of the measuring area (too high or too wide piece).
10	Barcode is read in tracking (barcode registering only) mode. This is a normal status code when the system is running in such mode. This code shall not be interpreted as an exception.
11	Zero dimensions. Item is detected by the dimensioning instrument but the size is set to zero due to the item shape or size. Too small or large items may be reported with zero measurements. This depends on the dimensioning instrument configuration parameters.
12	Weight information is not captured. May be caused by operational issues (abnormal packages flow on the conveyors) or low profile items that are not detected by the scale instrument (photo eye limitations).
13	Multiple volume readouts are captured for a single item. This is usually caused by bad items flow (multiple non-separated items are detected in the measuring area) or a bad item shape (single non-cuboidal item is "seen" as multiple smaller objects by dimensioning instrument).
14	Multiple weight readouts are captured for a single item. Caused by multiple non-separated items on the scale or unsupported items are processed - same item triggers the scale multiple times due to a specific item shape.
	Dimensioning related codes
51	Package out of measuring area. Operational error. Package is partly outside of the valid measuring field
52	Package is too small for measuring. Operational error. Package cannot be measured due to its size.
53	Package is too long for measuring. Operational error. Package cannot be measured due to its size.
54	Package is too high for measuring. Operational error. Package cannot be measured due to its size.
56	Package is too small for legal measuring. Operational error. Package measurements cannot be reported due to its size. Legal measurement limits are set in dimensioning instrument configuration. Those limits prevent reporting measurements that are outside of limits defined by local authorities or due to instrument accuracy

57	Package is too big for legal measuring. Operational error. Package measurements cannot be reported due to its size. Legal measurement limits are set in dimensioning instrument configuration. Those limits prevent reporting measurements that are outside of limits defined by local authorities or due to instrument accuracy.
58	Package is not cuboidal. Operational error. Package measurements cannot be reported due to its irregular shape. Instrument is set up to measure only rectangular boxes. Abnormal shape causes such code to be reported. Make sure that there are no straps, tape or any other visible pieces outside of the box.
59	Sensor error. Dimensioning instrument reports measuring sensor detection problem.
60	Piece is in shadow. Operational error. Piece is in shadow of another object and cannot be measured.
61	Reflection problems. Dimensioning instrument reports measuring problems due to light reflections from the piece surface. Might be caused by bad light or by too reflective piece surface.
62	Too complex shape. Dimensioning instrument reports measuring error caused by piece shape. Piece cannot be measured.
63	Impossible to measure due to shape. Dimensioning instrument reports measuring error caused by a specific shape.
64	Measuring failed. Dimensioning instrument reports measuring error due to other reason not covered by given codes above.
66	Measuring failed. Multiple objects inside measuring area.
Weighing related codes (show on OCTO)	
84	Underload. Scale is not able to measure, too light piece.
85	Overload. Scale is not able to measure, too heavy piece.
86	Under minimum weight. Weight value cannot be reported, due to too light piece. Weigh is under legally approved minimum value.
87	Over maximum weight. Weight value cannot be reported, due to too heavy piece. Weigh is over legally approved maximum value.

Code	Explanation
Unified dimensioning status codes	
00	VALID MEASUREMENT
01	OUTSIDE MEASUREMENT AREA
02	TOO SMALL PACKAGE
03	TOO LONG PACKAGE
04	TOO HIGH PACKAGE
05	RESULT TOO LATE
06	UNDER MINIMUM DIMENSIONS
07	OVER MAXIMUM DIMENSIONS
08	PACKAGE NOT CUBOIDAL
09	NO SENSOR DETECTION
10	IN SHADOW
11	REFLECTION PROBLEM
12	PACKAGE TOO COMPLEX

13	DIMENSIONING IMPOSSIBLE
14	MEASURING FAILED
16	MULTIPLE
29	MOUSETRAP / TRAY
	Unified weighing status codes (show on OCTO)
00	VALID WEIGHT
01	SCALE WAS UNSTABLE
02	TOO LONG FOR WEIGHING
03	MULTIPLE ON SCALE
04	SCALE UNDERLOAD
05	SCALE OVERLOAD
06	UNDER MINIMUM WEIGHT
07	OVER MAXIMUM WEIGHT
08	NO SCALE DATA
09	SCALE TIMEOUT
10	WEIGHING IMPOSSIBLE
11	TOO SHORT WEIGHING TIME

www.mt.com/TLX

For more information

Mettler-Toledo

30318459 R1.03